



MODEL NO. : TM043NBH02-40

ISSUED DATE: 2015-4-23

VERSION : Ver 1.0

- Preliminary Specification**
- Final Product Specification**

Customer : _____

Approved by	Notes

SHANGHAI TIANMA Confirmed :

Prepared by	Checked by	Approved by

This technical specification is subjected to change without notice



Table of Contents

Table of Contents.....	2
Record of Revision	3
1 General Specifications	4
2 Input/Output Terminals	5
3 Absolute Maximum Ratings	7
4 Electrical Characteristics.....	8
5 Timing Chart	11
6 Optical Characteristics	18
7 Environmental / Reliability Tests	21
8 Mechanical Drawing	22
9 Packing Drawing.....	23
10 Precautions for Use of LCD Modules	24



Record of Revision

Rev	Issued Date	Description	Editor
1.0	2015-04-20	Preliminary Specification Release	Yan Hongkang



1 General Specifications

	Feature	Spec
Display Spec.	Size	4.3 inch
	Resolution	480(RGB)x272
	Interface	RGB 24 bits
	Color Depth	16.7M
	Technology Type	a-Si
	Pixel Configuration	R.G.B Vertical Stripe
	Display Mode	TN,NW
	Surface Treatment	AG
	Viewing Direction	6 o'clock
	Gray Scale Inversion Direction	12 o'clock
Mechanical Characteristics	LCM (W x H x D) (mm)	105.50x67.20x4.10
	Active Area(mm)	95.04x53.856
	With /Without TSP	With TSP
	Weight (g)	TBD
	LED Numbers	10 LEDs

Note 1: Viewing direction for best image quality is different from TFT definition. There is a 180 degree shift.

Note 2: Requirements on Environmental Protection: Q/S0002

Note 3: LCM weight tolerance: $\pm 5\%$



2 Input/Output Terminals

2.1 TFT LCD Panel

No	Symbol	I/O	Description	Comment
1	VLED-	P	Back light cathode	
2	VLED+	P	Back light anode	
3	GND	P	Ground	
4	VDD	P	Power supply	
5	R0	I	Red Data input	
6	R1	I	Red Data input	
7	R2	I	Red Data input	
8	R3	I	Red Data input	
9	R4	I	Red Data input	
10	R5	I	Red Data input	
11	R6	I	Red Data input	
12	R7	I	Red Data input	
13	G0	I	Green Data input	
14	G1	I	Green Data input	
15	G2	I	Green Data input	
16	G3	I	Green Data input	
17	G4	I	Green Data input	
18	G5	I	Green Data input	
19	G6	I	Green Data input	
20	G7	I	Green Data input	
21	B0	I	Blue Data input	
22	B1	I	Blue Data input	
23	B2	I	Blue Data input	
24	B3	I	Blue Data input	
25	B4	I	Blue Data input	
26	B5	I	Blue Data input	
27	B6	I	Blue Data input	
28	B7	I	Blue Data input	
29	GND	P	Ground	
30	DCLK	I	Clock signal; latching data at the rising edge	
31	DISP	I	Display control / standby mode selection, Internal pull low. DISP = "Low" : Standby; DISP = "High" : Normal display	
32	HSYNC	I	Horizontal sync signal; negative polarity	
33	VSYNC	I	Vertical sync signal; negative polarity	

The information contained herein is the exclusive property of SHANGHAI TIANMA MICRO-ELECTRONICS Corporation, and shall not be distributed, reproduced, or disclosed in whole or in part without prior written permission of SHANGHAI TIANMA MICRO-ELECTRONICS Corporation.



34	DE	I	Data input enable. Active High to enable the data input When not used in SYNC mode, user should connect it to "Low".	
35	NC	—	No connection	
36	GND	P	Ground.	
37	X_R	O	XR	
38	Y_B	O	YD	
39	X_L	O	XL	
40	Y_T	O	YU	

Note 1: I Input * O Output * P Power/Ground



3 Absolute Maximum Ratings

3.1 Driving TFT LCD Panel

Ta =25℃

Item	Symbol	MIN	MAX	Unit	Remark
Supply Voltage	VDD	-0.3	4.6	V	
Logic Input Voltage Range	VIN	-0.3	VDDI+0.3	V	
Logic Output Voltage Range	VO	-0.3	VDDI+0.3	V	
Back Light Forward Current	I _{LED}		25	mA	For each LED
Operating Temperature	T _{OPR}	-20	70	℃	
Storage Temperature	T _{STG}	-30	80	℃	



4 Electrical Characteristics

4.1 Driving TFT LCD Panel

GND=0V * Ta=25℃

Item	Symbol	MIN	TYP	MAX	Unit	Remark
Supply Voltage	VDD	3.0	3.3	3.6	V	
NVM Supply Voltage	VPP	7.4	7.5	7.6	V	
Input Signal Voltage	Low Level	V _{IL}	DGND	ü	0.3xVDD	V
	High Level	V _{IH}	0.7xVDD	ü	VDD	V
Output Signal Voltage	Low Level	V _{OL}	DGND	ü	DGND+0.4	V
	High Level	V _{OH}	VDD-0.4	ü	VDD	V
(Panel+LSI) Power Consumption	Black Mode (60Hz)		TBD		mW	
	Standby Mode		TBD		mW	

4.2 Backlight Unit

Ta=25℃

Item	Symbol	MIN	TYP	MAX	Unit	Remark
Forward Current	I _F	--	40	50	mA	10 LEDs (2 LED Serial, 5 LED Parallel)
Forward Current Voltage	V _F	--	16	18	V	
Backlight Power Consumption	W _{BL}	--	640	ü	mW	
LED life time	--	10000	(20000)	-	Hrs	

Note1: The LED driving condition is defined for each LED module (5 LED Serial, 2 LED Parallel).

Note2: Under LCM operating, the stable forward current should be inputted. And forward voltage is for reference only.

Note3: I_F is defined for one channel LED. Optical performance should be evaluated at Ta=25℃ only. If LED is driven by high current, high ambient temperature & humidity condition. The life time of LED will be reduced. Operating life means brightness goes down to 50% initial brightness. Typical operating life time is estimated data.

Note4: The LED driving condition is defined for each LED module.

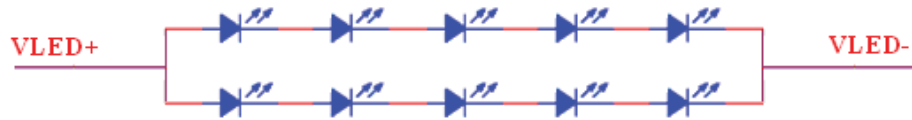



4.3 Block Diagram

LCD module diagram

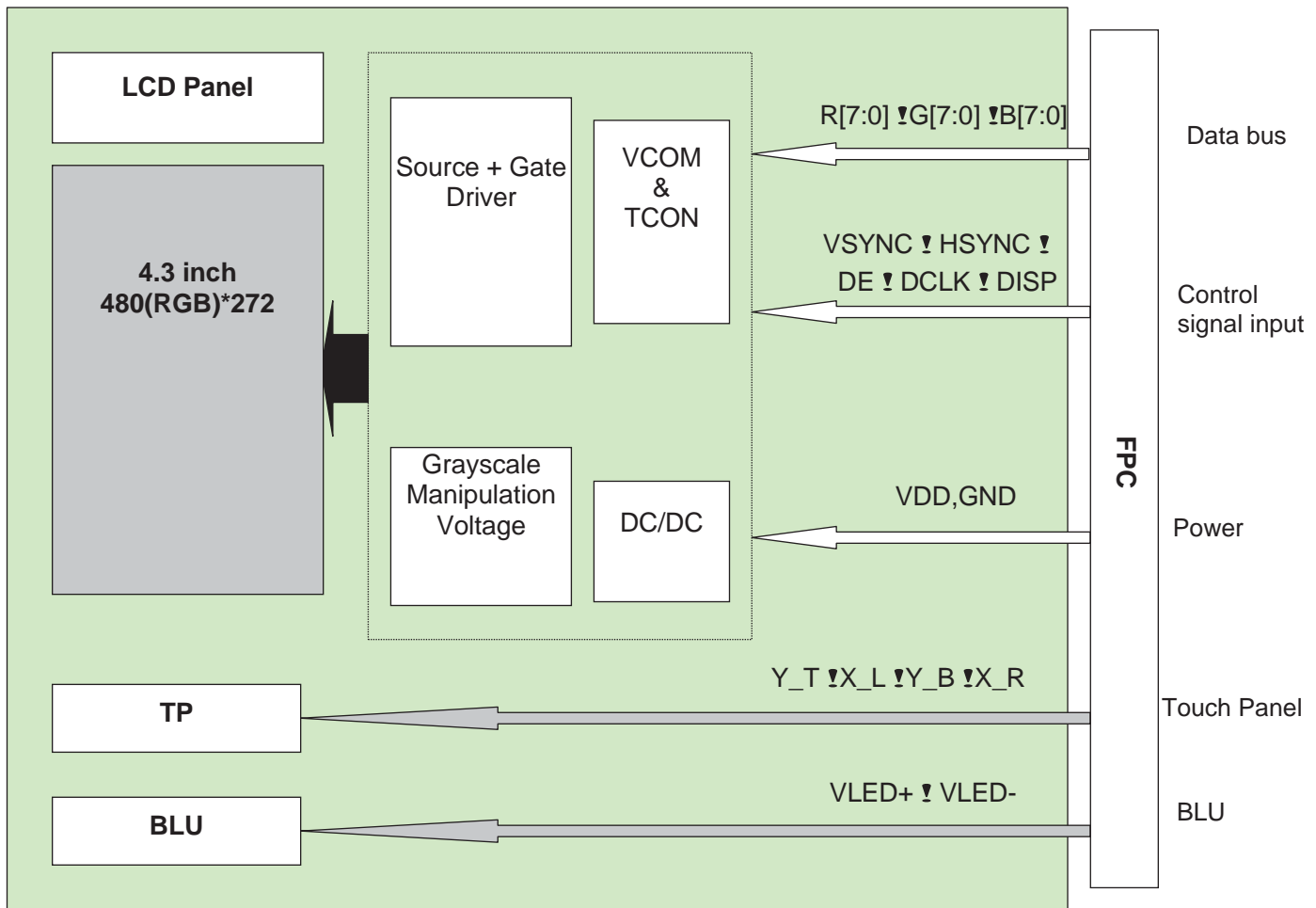



5 Timing Chart

5.1 Clock and Data Input Timing Diagram

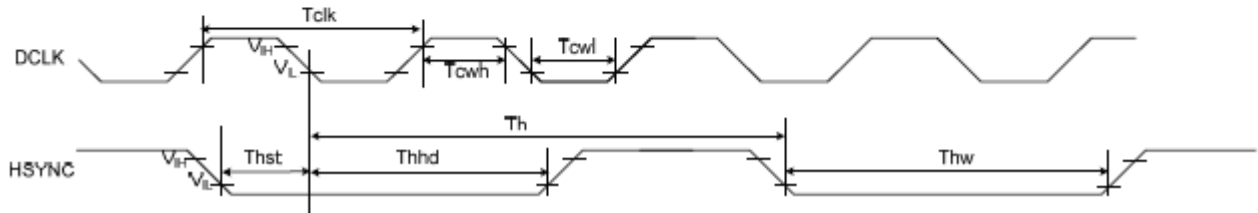
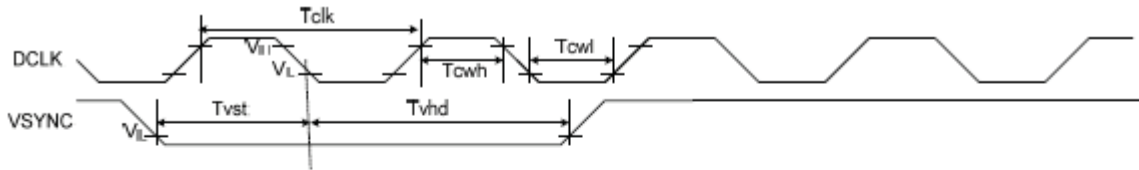

SYNC MODE



SYNC-DE MODE

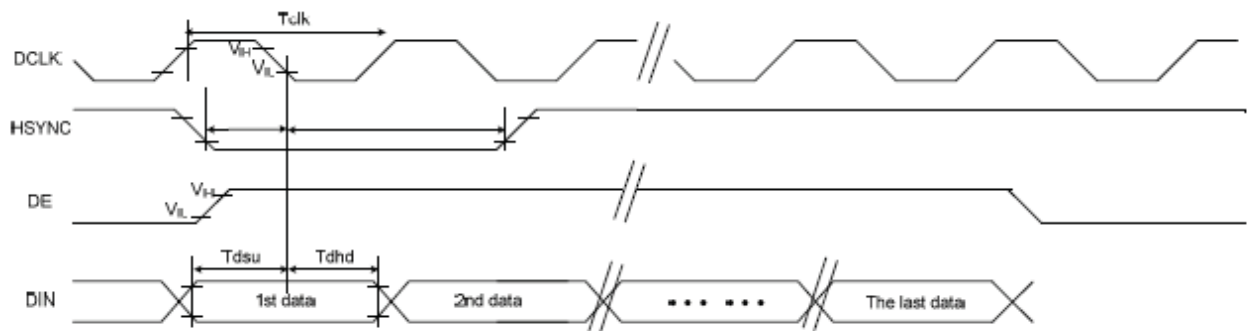

**AC Characteristics**

VDDI= 3.3V, VDD= 3.3V, AGND= 0V

Item	Symbol	Min.	Typ.	Max.	Unit	Conditions
System operation timing						
VDD power source slew time	TPOR	-	-	20	ms	From 0V to 99% VDD
GRB pulse width	tRSTW	10	50	-	us	R=10Kohm, C=1uF
Input/ Output timing						
CLK pulse duty	T _{cd}	40	50	60	%	
Hsync width	T _{hw}	1	-	-	DCLK	
Hsync period	T _h	55	60	65	us	
Vsync setup time	T _{vst}	12	-	-	ns	
Vsync hold time	T _{vhd}	12	-	-	ns	
Hsync setup time	T _{hst}	12	-	-	ns	
Hsync hold time	T _{hhd}	12	-	-	ns	
Data setup time	T _{dsu}	12	-	-	ns	
Data hold time	T _{dhd}	12	-	-	ns	
SD output stable time	T _{st}	-	-	12	us	Output settled within +20mV Loading = 6.8k+28.2pF.
GD output rise and fall time	T _{gst}	-	-	6	us	Output settled (5%~95%), Loading = 4.7k+29.8pF



5.2 Data Input Format

5.2.1 Parallel 24-bit RGB Data Input Timing Diagram under SYNC Mode

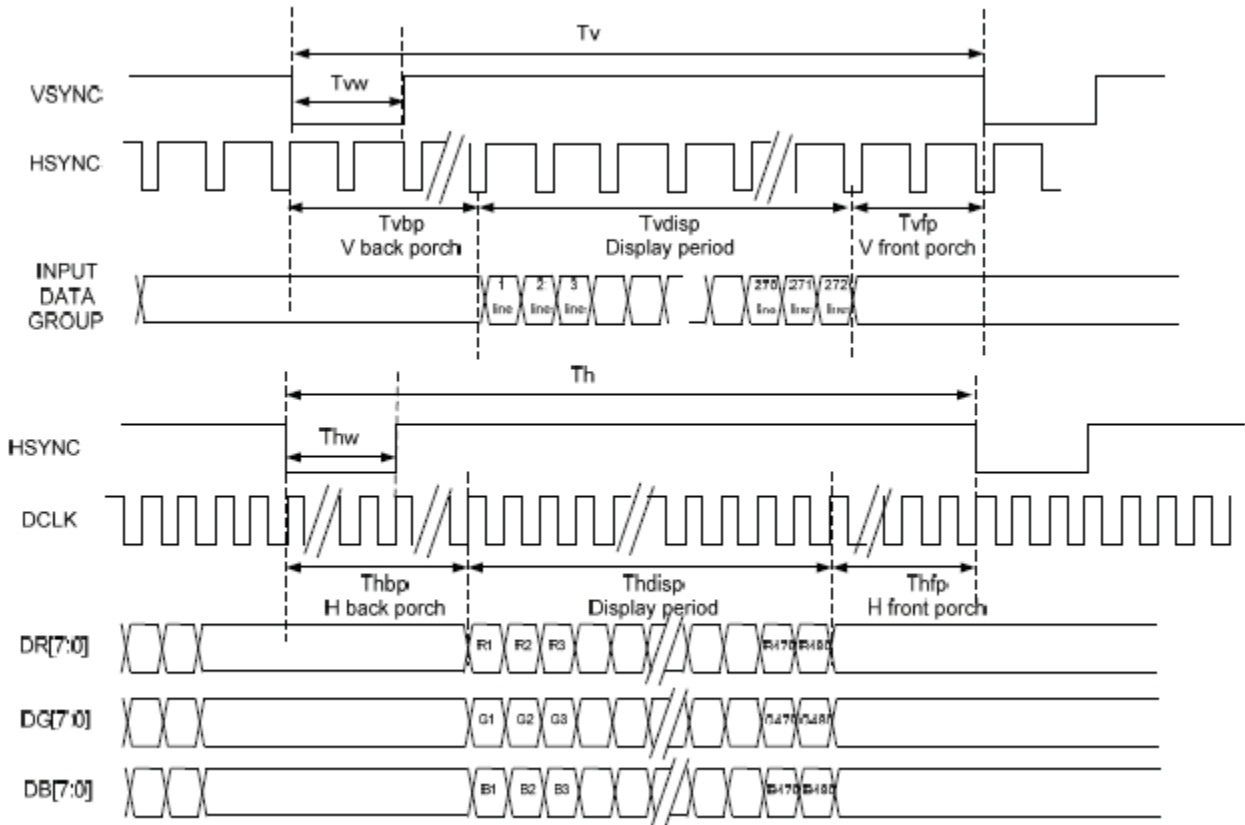



5.2.2 Parallel 24-bit RGB Data Input Timing Diagram under SYNC-DE Mode

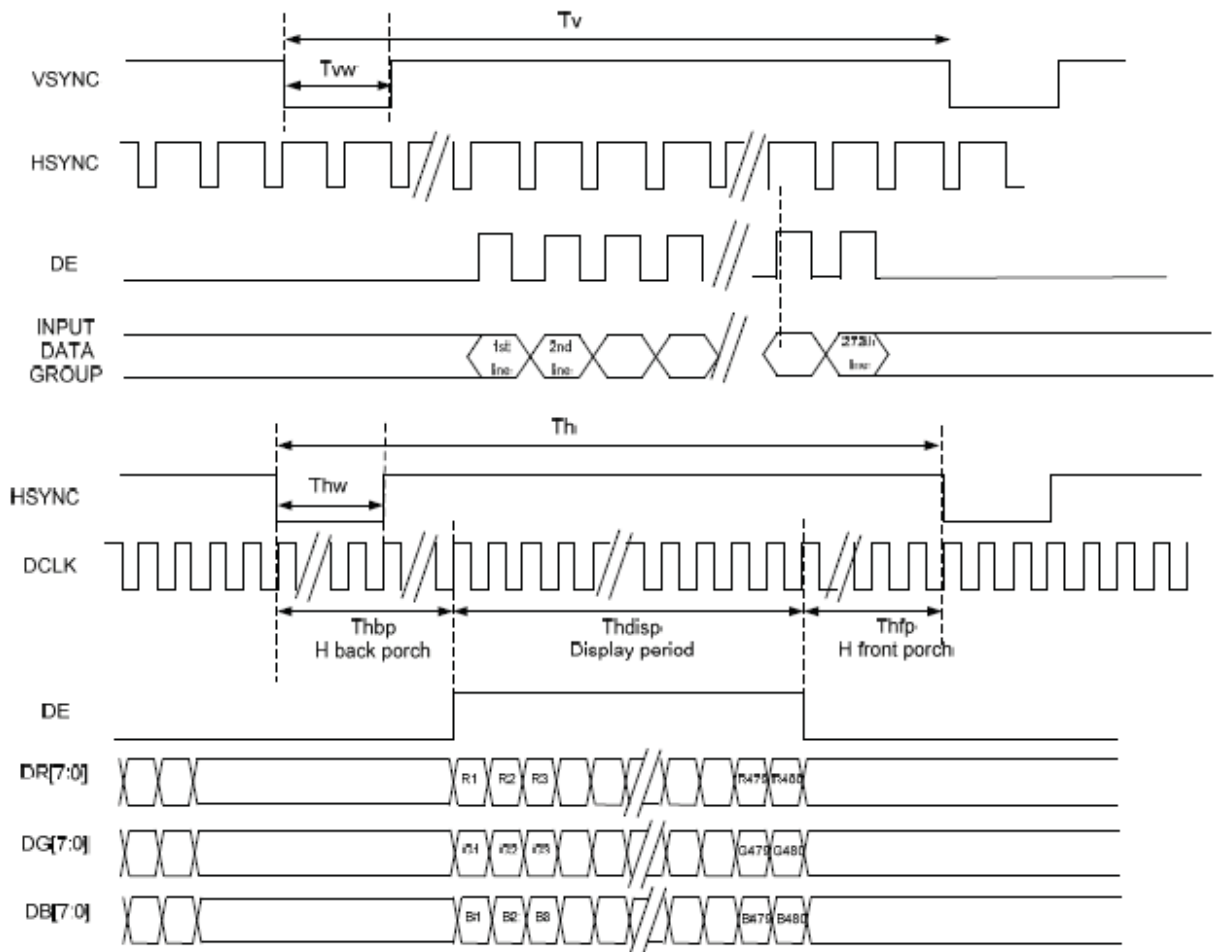



5.3 Data Input Timing Parameter Setting

Item	Symbol	Min.	Typ.	Max.	Unit	Remark	
DCLK Frequency	Fclk	8	9	12	MHz		
DCLK Period	Tclk	83	111	125	ns		
HSYNC	Period Time	Th	485	531		DCLK	
	Display Period	Thdisp		480		DCLK	
	Back Porch	Thbp	3	43		DCLK	By H_Blanking setting
	Front Porch	Thfp	2	8		DCLK	
	Pulse Width	Thw	2	4		DCLK	
VSYNC	Period Time	Tv	276	292		H	
	Display Period	Tvdisp		272		H	
	Back Porch	Tvbp	2	12		H	By V_Blanking setting
	Front Porch	Tvfp	2	8		H	
	Pulse Width	Tvw	2	4		H	



5.4 Power ON Sequence

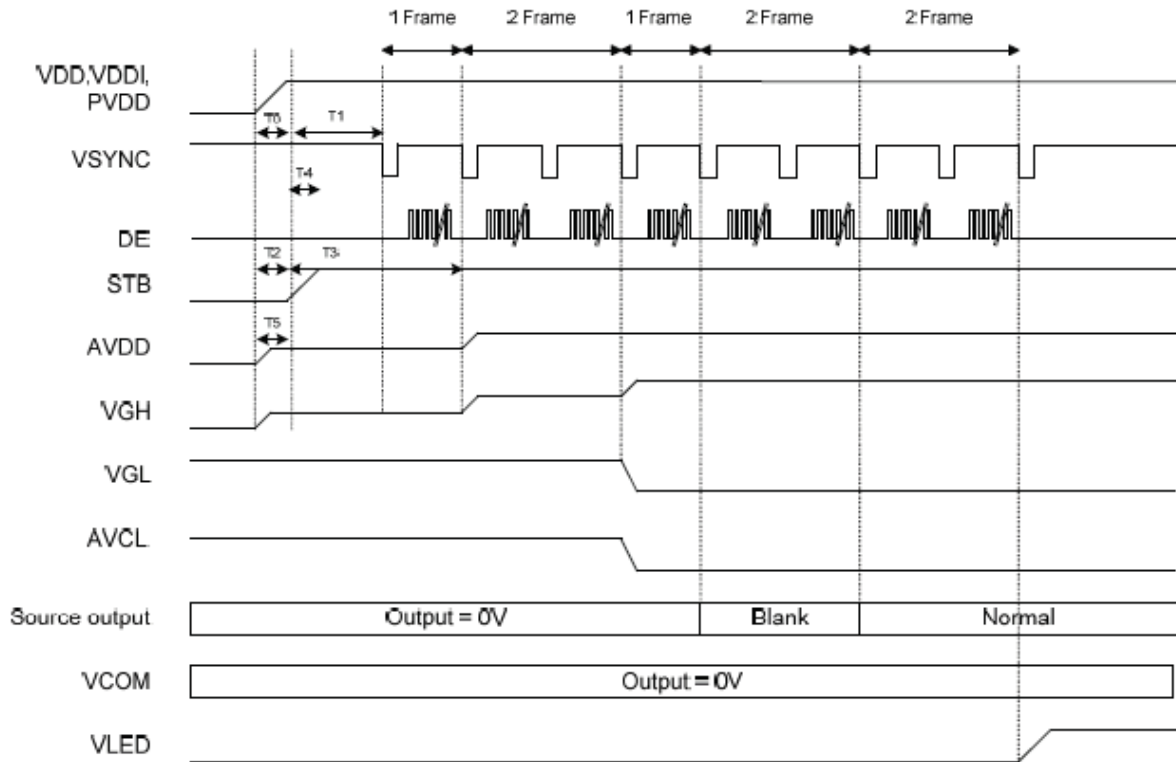

	Description	Min. Time
T0	Determined by the external power	
T1	Time from stable VDD, VDDI, PVDD set-up to the first VSYNC	T1=0
T2	Time from AVDD=0V to AVDD=3.3V	T2=T0
T3	Time from AVDD=3.3V to AVDD=6.0V	T3=T1+ (1*Frame)
T4	Time from stable VDD, VDDI, PVDD set-up to DISP asserted	T4=0
T5	Time from VGH=0V to VGH=3.3V	T5=T0



5.5 Power Off Sequence

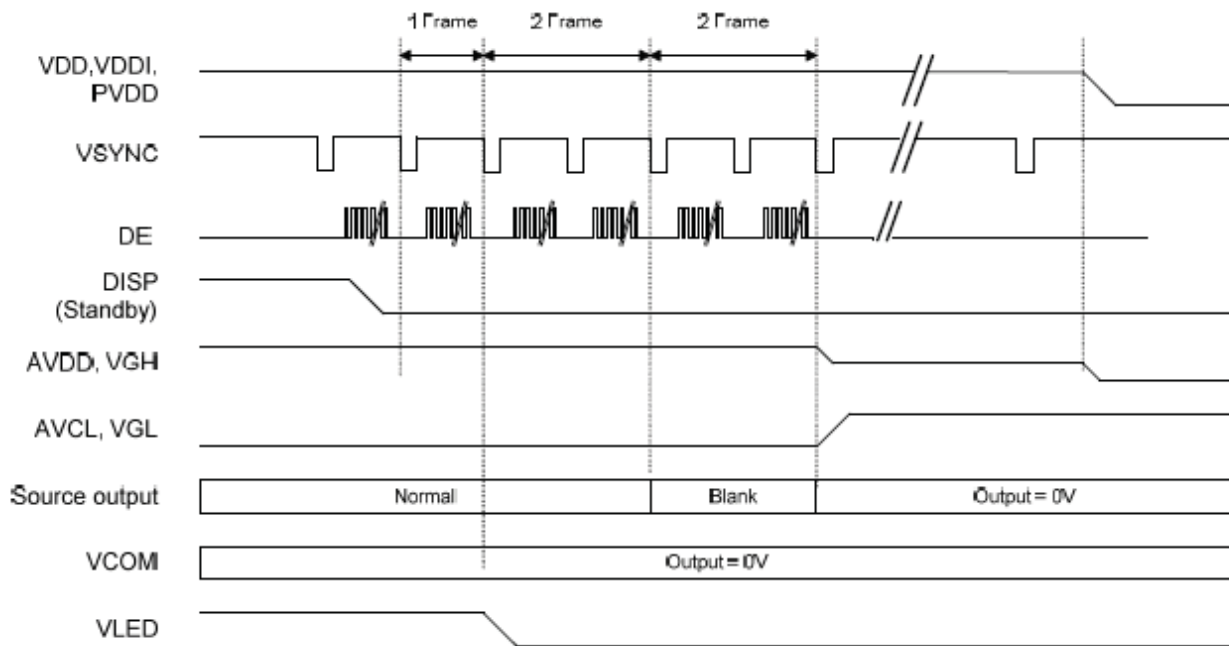



6 Optical Characteristics

Ta=25℃

Item	Symbol	Condition	Min	Typ	Max	Unit	Remark	
View Angles	θT	CR ₁₀	60	70	-	Degree	Note2,3	
	θB		40	50	-			
	θL		60	70	-			
	θR		60	70	-			
Contrast Ratio	CR	$\theta=0^\circ$	600	800	-		Note 3	
Response Time	T _{ON}	25℃	-	20	30	ms	Note 4	
	T _{OFF}							
Chromaticity	White	Backlight is on	x	0.257	0.307	0.357		Note 1,5
			y	0.28	0.33	0.38		
	Red		x	0.532	0.582	0.632		Note 1,5
			y	0.299	0.349	0.399		
	Green		x	0.294	0.344	0.394		Note 1,5
			y	0.538	0.588	0.638		
	Blue		x	0.101	0.151	0.201		Note 1,5
			y	0.049	0.099	0.149		
Uniformity	U			75	-	%	Note 6	
NTSC			-	50	-	%	Note 5	
Luminance	L		250	300	-	cd/m ²	Note 7	

Test Conditions:

1. I_F= 22 mA, and the ambient temperature is 25℃.
2. The test systems refer to Note 1 and Note 2.



Note 1: Definition of optical measurement system.

The optical characteristics should be measured in dark room. After 5 Minutes operation, the optical properties are measured at the center point of the LCD screen. All input terminals LCD panel must be ground when measuring the center area of the panel.

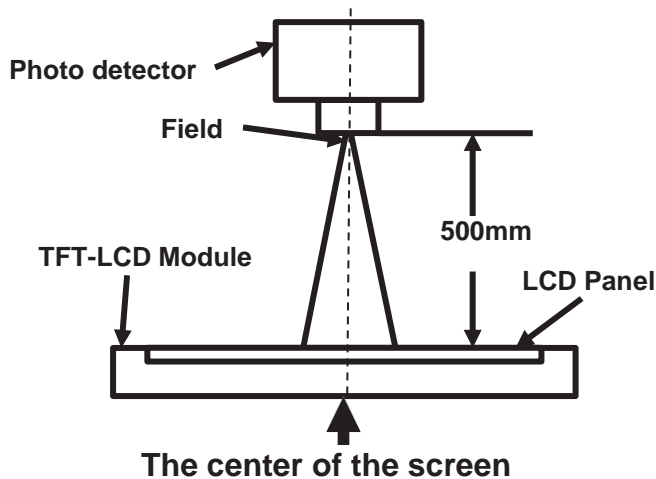

Item	Photo detector	Field
Contrast Ratio	SR-3A	1°
Luminance		
Chromaticity		
Lum Uniformity		
Response Time	BM-7A	2°

Note 2: Definition of viewing angle range and measurement system.

viewing angle is measured at the center point of the LCD by CONOSCOPE(ergo-80)DŽ

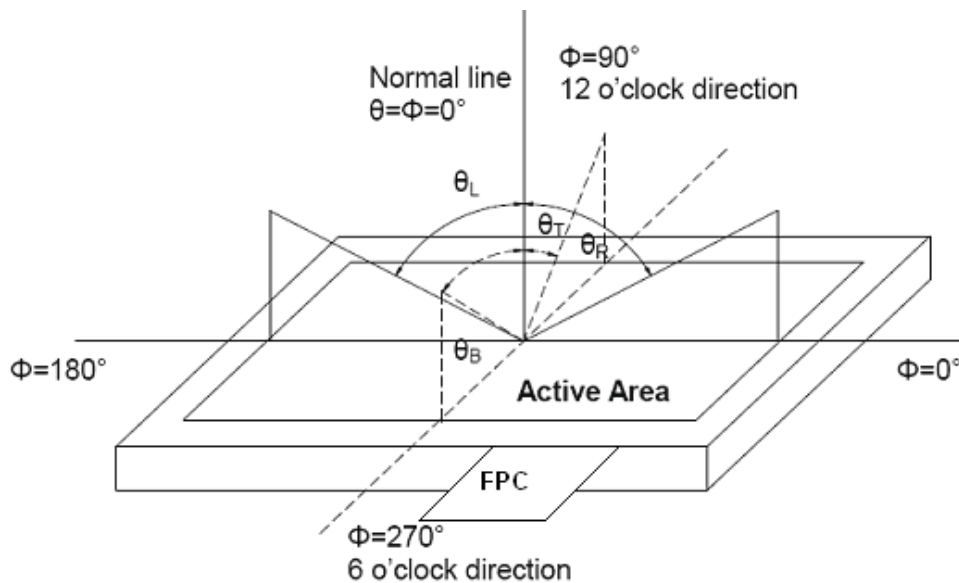

Note 3: Definition of contrast ratio

$$\text{Contrast ratio (CR)} = \frac{\text{Luminance measured when LCD is on the "White" state}}{\text{Luminance measured when LCD is on the "Black" state}}$$

“White state “: The state is that the LCD should drive by Vwhite.

“Black state”: The state is that the LCD should drive by Vblack.

Vwhite: To be determined Vblack: To be determined.



Note 4: Definition of Response time

The response time is defined as the LCD optical switching time interval between “White” state and “Black” state. Rise time (TON) is the time between photo detector output intensity changed from 90% to 10%. And fall time (TOFF) is the time between photo detector output intensity changed from 10% to 90%.

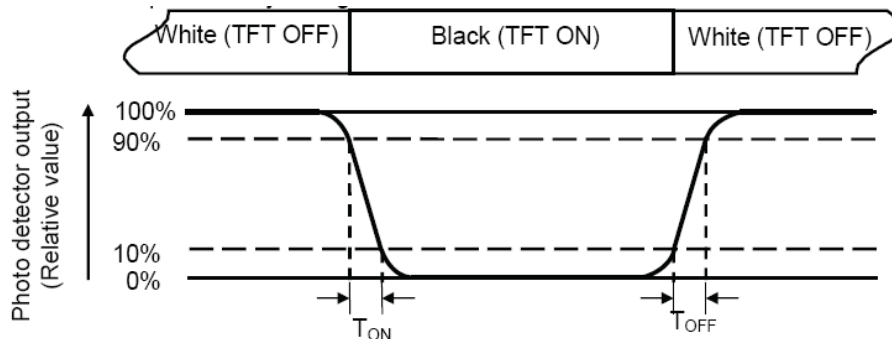

Note 5: Definition of color chromaticity (CIE1931)

Color coordinates measured at center point of LCD.

Note 6: Definition of Luminance Uniformity

Active area is divided into 9 measuring areas (Refer Fig. 2). Every measuring point is placed at the center of each measuring area.

Luminance Uniformity (U) = Lmin/ Lmax

L-----Active area length W----- Active area width

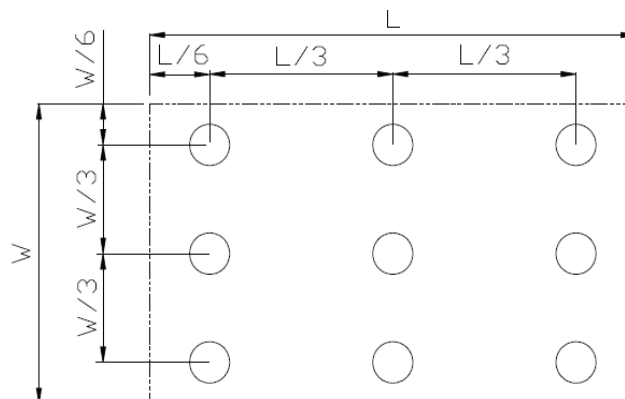

Lmax: The measured Maximum luminance of all measurement position.

Lmin: The measured Minimum luminance of all measurement position.

Note 7: Definition of Luminance:

Measure the luminance of white state at center point.

**7 Environmental / Reliability Tests**

No	Test Item	Condition	Remarks
1	High Temperature Operation	Ts=+70℃, 240hrs	Note1 IEC60068-2-1,GB2423.2
2	Low Temperature Operation	Ta=-20℃, 240hrs	IEC60068-2-1 GB2423.1
3	High Temperature Storage	Ta=+80℃, 240hrs	IEC60068-2-1 GB2423.2
4	Low Temperature Storage	Ta=-30℃, 240hrs	IEC60068-2-1 GB2423.1
5	High Temperature & High Humidity Storage	Ta=+60℃, 90% RH 240 hours	Note2 IEC60068-2-78 GB/T2423.3
6	Thermal Shock (Non-operation)	-20℃ 30 min~+80℃ 30 min, Change time:5min, 100 Cycles	Start with cold temperature, End with high temperature, IEC60068-2-14,GB2423.22
7	Electro Static Discharge (Operation)	C=150pF, R=330Ω ⁵ points/panel Air:±8KV, 5times; Contact:±4KV, 5 times; Environment: 15℃~35℃, 30%~60%, 86Kpa~106Kpa	IEC61000-4-2 GB/T17626.2
8	Vibration (Non-operation)	Frequency range:10~55Hz, Stroke:1.5mm Sweep:10Hz~55Hz~10Hz 2 hours for each direction of X.Y.Z. (6 hours for total)(Package condition)	IEC60068-2-6 GB/T2423.10
9	Shock (Non-operation)	60G 6ms, ±X,±Y,±Z 3times, for each direction	IEC60068-2-27 GB/T2423.5
10	Package Drop Test	Height:80 cm, 1 corner, 3 edges, 6 surfaces	IEC60068-2-32 GB/T2423.8
11	Package Vibration Test	Random Vibration: 0.015GxG/Hz for 5-200Hz, -6dB/Octave from 200-500Hz 2 hours for each direction of X,Y,Z (6 hours for total)	IEC60068-2-34 GB/T2423.11

Note1: Ts is the temperature of panel's surface.

Note2: Ta is the ambient temperature of sample.



9 Packing Drawing

No	Item	Model (Material)	Dimensions(mm)	Unit Weight(Kg)	Quantity	Remark	
1	LCM module	TM043NBH02	105.5x67.2x4.1	0.0584	112		
2	Partition_1	Corrugated Paper	513x333x106	0.7	2		
3.	Anti-Static Bag	PE	175.8x125x0.05	0.0007	112	Anti-static	
4	Dust-Proof Bag	PE	700x530	0.0600	1		
5	Partition_2	Corrugated Paper	505x332x4.00	0.09	3		
6	Corrugated Bar	Corrugated Paper	513x117x3	0.04	8		
7	Carton	Corrugated Paper	530x350x250	1.1000	1		
8	Total weight	9.77±5% Kg					

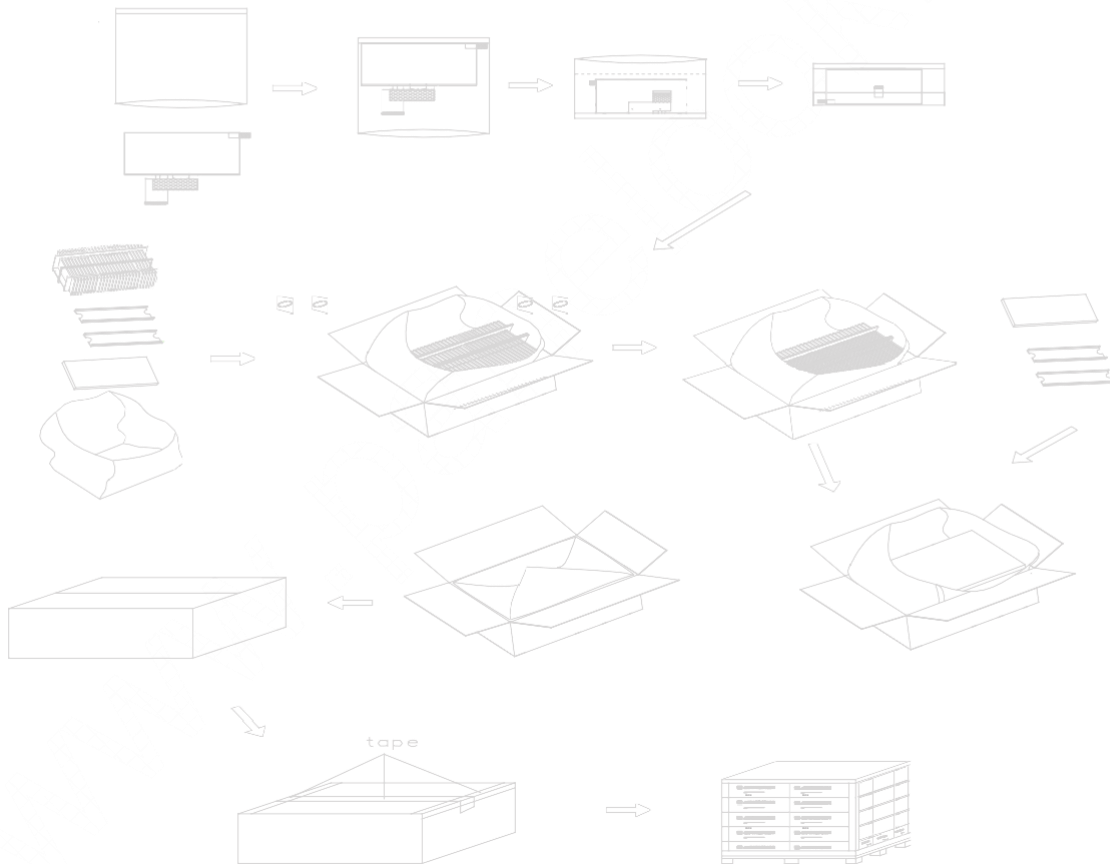



10 Precautions for Use of LCD Modules

10.1 Handling Precautions

10.1.1 The display panel is made of glass. Do not subject it to a mechanical shock by dropping it from a high place, etc.

10.1.2 If the display panel is damaged and the liquid crystal substance inside it leaks out, be sure not to get any in your mouth, if the substance comes into contact with your skin or clothes, promptly wash it off using soap and water.

10.1.3 Do not apply excessive force to the display surface or the adjoining areas since this may cause the color tone to vary.

10.1.4 The polarizer covering the display surface of the LCD module is soft and easily scratched. Handle this polarizer carefully.

10.1.5 If the display surface is contaminated, breathe on the surface and gently wipe it with a soft dry cloth. If still not completely clear, moisten cloth with one of the following solvents:

- Isopropyl alcohol
- Ethyl alcohol

Solvents other than those mentioned above may damage the polarizer. Especially, do not use the following:

- Water
- Ketone
- Aromatic solvents

10.1.6 Do not attempt to disassemble the LCD Module.

10.1.7 If the logic circuit power is off, do not apply the input signals.

10.1.8 To prevent destruction of the elements by static electricity, be careful to maintain an optimum work environment.

10.1.8.1 Be sure to ground the body when handling the LCD Modules.

10.1.8.2 Tools required for assembly, such as soldering irons, must be properly ground.

10.1.8.3 To reduce the amount of static electricity generated, do not conduct assembly and other work under dry conditions.

10.1.8.4 The LCD Module is coated with a film to protect the display surface. Be care when peeling off this protective film since static electricity may be generated.

10.2 Storage precautions

10.2.1 When storing the LCD modules, avoid exposure to direct sunlight or to the light of fluorescent lamps.

10.2.2 The LCD modules should be stored under the storage temperature range. If the LCD modules will be stored for a long time, the recommend condition is:

Temperature : 0℃ ~ 40℃ Relatively humidity: ≤80%

10.2.3 The LCD modules should be stored in the room without acid, alkali and harmful gas.

10.3 Transportation Precautions

10.3.1 The LCD modules should be no falling and violent shocking during transportation, and also should avoid excessive press, water, damp and sunshine.